

3.55" DEEP AIR DUCT

DCS airflow ducts are designed to help reduce energy consumption by containing hot or cold air paths to and from switches that are mounted into deep cabinets. This keeps hot exhaust air from entering the switch causing them to overheat and potentially shut down. The open front allows access to replace fan modules or power supplies without removing the duct. They come in various rack units (RU), depths, and colors. DCS Air Ducts are RoHS compliant, aluminum construction, and welded for maximum air containment.

PRODUCT SPECIFICATIONS

Product Type

Air Duct

Product Series

Passive Airflow Management

Features & Benefits

- Mounts in 19-inch Rack
- RoHS Compliant
- Aluminum Construction
- Welded

Dimensions

Configuration	Height	Width	Depth
1U	1.72"	19.00"	3.55"
2U	3.47"	19.00"	3.55"
3U	5.22"	19.00"	3.55"
4U	6.97"	19.00"	3.55"
5U	8.72"	19.00"	3.55"
6U	0.47"	19.00"	3.55"

Colors

ECO/Silver

Black

(Other Colors Available Upon Request)

Note: All pictures shown are for illustration purposes only. Actual product may vary due to product enhancement.

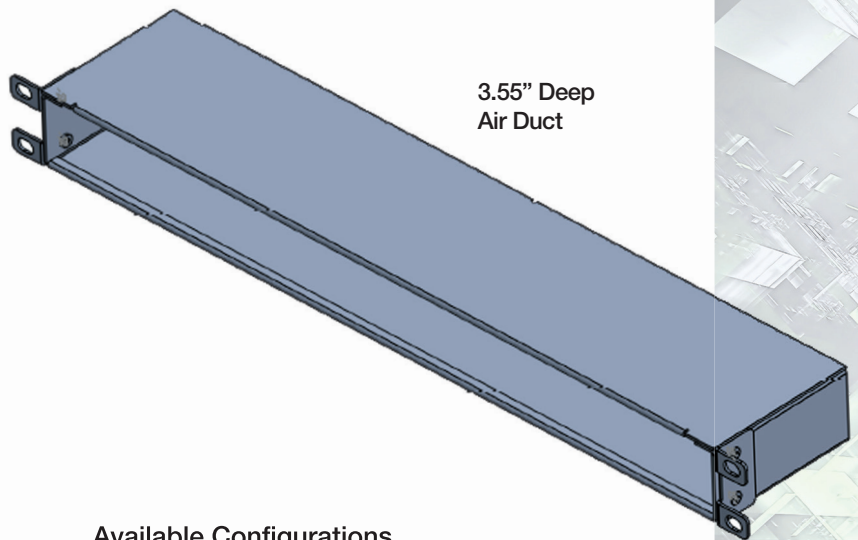

Available Configurations

Item Number	Configuration	Color*
751-0111-001	1U	Black
751-0111-002	1U	ECO/Silver
752-0122-001	2U	Black
752-0122-002	2U	ECO/Silver
753-0101-001	3U	Black
753-0101-002	3U	ECO/Silver
754-0113-001	4U	Black
754-0113-002	4U	ECO/Silver
755-0100-001	5U	Black
755-0100-002	5U	ECO/Silver
756-0106-001	6U	Black
756-0106-002	6U	ECO/Silver

*Other Colors Available Upon Request

FIND OUT HOW DCS' CONNECTIVITY SOLUTIONS CAN IMPROVE YOUR COMPANY'S PERFORMANCE.

972-620-4997 | 1881 Valley View Lane, Dallas, Texas 75234 | salesupport@datacentersystems.com

Confidential: This document contains information of a proprietary nature to Data Center Systems. Any reproduction, use or dissemination of said information in whole or part without the express written consent to Data Center Systems is prohibited.

